



BITUMINOUS

waterproofing solutions



bitumen-polymer
distilled membranes

◎ CERTIFICATIONS	6-7
◎ FEATURES	8
◎ QUALITY	9
◎ CE MARKING	10
◎ LABELLING	11
◎ DOCUMENTATION	12
◎ DATAQUAD 2000	13
◎ PRODUCTS AND FIELDS OF USE	14
◎ PARALON	15-16
◎ COMPOSITION	17
◎ SURFACE TREATMENTS	18
◎ KEY	19
◎ INSTALLATION INSTRUCTIONS	20
◎ STORAGE AND HANDLING	21

● ELASTOMERIC	
PARAFLEX	23
TECNOFLEX	23
● ELASTO CO-POLYMERIC	
BITEXTENE FLEX MT	24
TEXTENE FLEX	24
● ELASTOPHINIC	
STAR	25
● LIGHTWEIGHT WITH LOW SPECIFIC WEIGHT	
LEVIFLEX	26
● ELASTOPLASTOMERIC HIGH PERFORMANCE LEVEL	
PARALON ^{PLUS} ST	27
● ELASTOPLASTOMERIC	
UNOSINT	28
SINTOPLENE	28
PARAGUM ST	29
TOP	29
CENTRO	30
SINTOGUM	30
● FIRE RESISTANCE	
PARALON ^{PLUS} ST FIRE	31
● INSTALLATION WITH COLD ADHESIVES	
PARALON COLD SYSTEM	32
ADITHENE	32
● SHIELDS, VAPOUR BARRIERS AND INSULATING PANEL BONDING	
VAPOBAR	33
ADEVAPOR 35	33

<ul style="list-style-type: none"> ● ANTI-ROOT ROOF GARDENS <ul style="list-style-type: none"> PARALON ANTI-ROOT 34 UNOSINT ANTI-ROOT 34 	
<ul style="list-style-type: none"> ● PARKING LOTS, BRIDGES, VIADUCTS AND ROADS <ul style="list-style-type: none"> SINTOPLENE 3 AV 35 UNOSINT 4/25 AV 35 THERMO STICKER PONTS HP 35 	
<ul style="list-style-type: none"> ● PROTECTION FROM RADON GAS <ul style="list-style-type: none"> SICURBAR 36 	
<ul style="list-style-type: none"> ● PARTIAL ADHESION APPLICATION <ul style="list-style-type: none"> MULTIHOLES S/40 36 	
<ul style="list-style-type: none"> ● RESTORING OLD PAVEMENTS <ul style="list-style-type: none"> PARAFLEX MS 37 PARALON^{PLUS} MS 37 	
<ul style="list-style-type: none"> ● WATERPROOFING SYSTEMS SELF-ADHESIVE AND THERMO-ADHESIVE <ul style="list-style-type: none"> STICKER HP 38 STICKER HP ARD 38 STICKER BIADESIVO 39 STICKER 39 STICKER ARD 39 	
<ul style="list-style-type: none"> ● PRIMERS <ul style="list-style-type: none"> IMPERTENE PRIMER 40 PRIMER BIT 40 PRIMER WB 40 	
<ul style="list-style-type: none"> ● PROTECTIVE PAINTS FOR WATERPROOFING PAVEMENTS <ul style="list-style-type: none"> NEROBIT 41 PARWENOL 41 ELASTOMUL G 41 ELASTOMUL SB 41 	



ALMOST A CENTURY OF EXPERIENCE

IMPERIA ITALIA was founded in Turin in 1936 for the production of water proofing products, sealants and bitumen emulsions, used to waterproof roofs, foundations, water basins, dams, channels and other construction works.

Subsequently, the Company responded - by manufacturing special coverings - to a growing need on the market to protect large structures and steel systems from corrosion (viaducts, tanks, penstocks, large structural metal works).

Next IMPER ITALIA completed the above-mentioned products and protective cycles with the production of formulated products for the protection, maintenance and restoration of concrete works.

All of this took place while the Company was affirming its position in the waterproofing sector as one of the worldwide leaders in the production of bitumen-polymer waterproofing membranes (during the 60's) and of new generation synthetic membranes made of TPO/FPA polypropylene based elastomerised polyolefin (during the 90's).



IMPER ITALIA HAS ALWAYS BEEN ACTIVE IN IMPROVING ITS PRODUCTION PROCESSES, IN ORDER TO ENSURE MANAGEMENT ACCORDING TO EFFICIENCY, EFFECTIVENESS AND COST LOWERING CRITERIA.

THE QUALITY MANAGEMENT SYSTEM

QUALITY MANAGEMENT

In 1995 IMPER ITALIA obtained Certification of its own **Quality Management System according to International standard ISO 9001**, focusing its attention on Customer satisfaction through the "Continuous improvement" concept and insuring conformity to customer and applicable binding requirements.

WORKPLACE HEALTH AND SAFETY

Through the effort of all levels and company roles, in particular of the highest Management levels, the IMPER ITALIA organisation has implemented a workplace Health and Safety management System in order to satisfy requirements defined by law and Company Policy in terms of **workplace Health and Safety obtaining certification of its own Management System in conformity to the ISO 45001**

ENVIRONMENTAL MANAGEMENT

Furthermore, always demonstrating its focus on obtaining a good environmental performance level, IMPER ITALIA adopted an **Environmental Management System certified since 2012 in conformity to the ISO 14001 international Standard** that allows its Organisation to develop environmental policies, establish objectives and processes while keeping the environmental impact of its activities, products under control, in order to satisfy both legal limits and the requirements of our own Policy.



CERTIFICATIONS WORLDWIDE

IMPER PRODUCTS SUBJECT TO SPECIFIC TESTS BY BODIES AND QUALIFIED LABORATORIES, ARE CERTIFIED IN THE MAIN COUNTRIES AROUND THE WORLD.



Agréments and product Certifications issued by UEAtc Institutes (Union Européenne pour l'Agrément Technique dans la construction), **Certifications issued by overseas Institutes** (USA, New Zealand, Japan) to which one must add **recognitions and approvals issued by national companies** (ENEL, FFSS, Società Autostrade) that confirm the high level positioning of IMPER ITALIA in relation to the quality of the manufactured products.

PROCESS/PRODUCT CERTIFICATION

Due to the growing demand for products with a lower environmental impact, the bituminous membranes produced by IMPER ITALIA have a **process/product certification** that defines the percentage (%) of recycled material content according to defined parameters:

- **RATING SYSTEMS**

National and international, aimed at sustainable construction.
(LEED Reg. - Leadership in Energy and Environmental Design).

- **UNI EN ISO 14021**

Environmental Labels and Declarations.
Self-declared environmental claims (Type II environmental labelling).



SYSTEM FOR
QUALITY
MANAGEMENT



SYSTEM FOR
ENVIRONMENTAL
MANAGEMENT



HEALTH
AND SAFETY
AT WORK



(GBC)
SUSTAINABLE
CONSTRUCTION

IN ORDER TO OBTAIN GOOD LONG LASTING RESULTS, ONE MUST START FROM THE CORRECT DESIGN, FAVOURING QUALITY PRODUCTS AND INSTALLERS THAT COMPLY WITH MANUFACTURER INSTRUCTIONS.

QUALITY AND INSTALLATION

An important document for this sector, which should always be handled by waterproofing professionals, is the **CODE OF PRACTICE for Continuously Supported Coverings by IGLAE** (Istituto per la Garanzia dei Lavori Affini all'Edilizia - Institute Guaranteeing Works related to Construction).

Regarding membrane manufacturing, the raw materials must be continually checked and, due to their variety, compound formulation must be constantly adapted to those available.

This implies a wealth of expertise, support from an equipped laboratory, efficient production plants and processes, equipped with adequate controls and especially a well-rooted quality philosophy.

WEIGHT

There are misinterpretations, for example, regarding the grammage of "non-woven fabrics" of the polyester reinforcing mat.

The weight of this reinforcing mat is not of absolute importance since the quality evaluation must only refer to the entirety of technical characteristics and the performance: this performance in fact, is not connected exclusively to the weight, but

to the composition and processing of the reinforcing mat, in synergy with the polymer distilled bitumen compound that it is co-extruded in.

In recent years, the use of reinforced polyester "*non-woven fabrics*", with glass fibres or nets, has developed in order to make the polymer distilled bitumen membranes even more stable, dimensionally.

COLD FLEXIBILITY

Another misinterpretation takes place when confusing the "cold flexibility" of polymer distilled bitumen membranes with the possible "cold" breakage of the membranes during installation.

"Cold flexibility" is a value obtained in laboratory under test conditions according to the EN Standards that make it possible to obtain values that can be compared to the same product or between different products, without having any direct influence on unrolling the membranes at the construction site under various temperature conditions. Unrolling rolls in the construction site is much more severe than laboratory test

conditions and absolutely cannot be repeated.

The rolls may be subject to low temperature conditioning for weeks (outside or in construction sites) and a few hours of sun are not sufficient to bring back the inside of the roll to the application temperature (min. +5°C).

During installation, the unrolling time may be very fast (by kicking).

Since one of the determining factors for the positive result a waterproofing is the correct design, it is necessary to adopt waterproofing / insulation systems suitable for the types of structures treated and the use they are intended for, without overlooking the operational details of the surrounding works (drains, joints, thresholds, etc..).

Finally, one must consider the application quality, since product performance depends heavily on the skills of the installer.

The person installing it must therefore dose the flame and splice the sheets carefully as well as use adequate techniques to carry out surrounding works.



UPON SUPERFICIAL EXAMINATION, THE MEMBRANES OF DIFFERENT MANUFACTURERS LOOK THE SAME. THEY STAND OUT, HOWEVER, IN THEIR RELIABILITY, AS IN THE ABILITY TO RESIST OVER TIME, ONCE THEY HAVE BEEN APPLIED, THEIR ORIGINAL CHARACTERISTICS, WITH MINIMAL DECAY RATE, COMPARED TO THE MATERIAL USED.

THE “AGRÉMENTS” QUALITY CERTIFICATES

A support for choosing the best membranes is offered by the “**Technical suitability certificate**” (**Agrément technique**) issued by the **Official Institutes of the UEAtc (Union Européenne pour l’Agrément technique dans la construction)**, that groups together the most important Institutes of eleven European Countries. This Body has issued common directives regarding test methods and performance values, as well as application systems, to be able to perform the quality evaluation of the prefabricated polymer distilled bitumen membrane and of many other innovative materials intended for construction.

The BBA operates in England, the UBATC in Belgium, the CSTB in France, and so on and so forth in other European countries. These Institutes, when asked of the requesting manufacturer, take a sample of a specific product and carry out a preliminary investigation on product applications made over time.

They also carry out laboratory analysis, both on new product samples (in production and in stock), as well as on products applied over time, as well as in construction sites where the product being investigated is being applied. This is done in order to ensure that said product is truly compliant with the sample, using a complex and well-structured procedure.

The Agrément can only be issued to the requesting company at the end of all controls required by the procedure, controls that however are repeated, without giving advance notice, for the entire duration (five years) of the issued certificate. Upon expiration, the procedure is started over again. The institutes that issued an Agrément to our Companies periodically carry out controls on our self-monitoring system throughout the validity of the document.

QUALITY IN SERVICES

The performance quality of the waterproofing membranes also depends on their installation; IMPER ITALIA has a technical assistance service, competent in design and installation techniques, available for the most complex waterproofing problem, for product development, research, on site diagnostic visits, **for training installers (at a specific Training Centre in the Mappano Plant)**, for updating designers, to study solutions and technological systems aimed at optimising costs, for support in special works construction sites.



PROBLEM SOLVING AND CUSTOMER SATISFACTION

The IMPER ITALIA philosophy - understood as the set of essential principles of their own laws that guide the business - focus on “*customer satisfaction*”, with reference to the final user of the building.

The industrial vocation of IMPER ITALIA is expressed in complete consistency, gearing towards productions that aim at increasing the “*problem solving*” capacity in the building protection field, where the waterproofing concept is extended to its effects, in addition to water, also the infiltration of aggressive agents of any nature, in buildings.



The new service, called **Roofing Management Program**, is reserved for Important Customers and Large Projects, and consists in a new highly professional and integrated approach for design suggestion and the realisation of advance and environmentally friendly solutions for waterproofing roofs.

THE WATERPROOFING MEMBRANES IN POLYMER DISTILLED BITUMEN, DESTINED TO SPECIFIC FIELDS OF USE, ARE SUBJECT TO MANDATORY CE MARKING. IT IS THEREFORE PROHIBITED TO PLACE ON THE MARKET, FREE CIRCULATION THROUGHOUT THE EUROPEAN COMMUNITY, BITUMEN MEMBRANES WITHOUT CE MARKING (FOR THE USES WHERE THE OBLIGATION IS APPLICABLE).



THE CE MARKING

Is necessary to certify suitability of the membrane for the specified uses, and is intended to safeguard the consumer. It is placed by the manufacturer based on Regulation (EU) n. 305/2011 of the European Parliament and the council of March 9th 2011 (that sets harmonised conditions for the commercialisation of construction products and that repeals directive 89/106/EEC of the Council), under supervision of a Notified Body, for certification and supervision attesting conformity of the "factory production control".

- **THE MANUFACTURER IS RESPONSIBLE** operationally to structure suitable manufacturing and control activities that are suitable to obtain waterproofing membranes that comply with the harmonised reference standards for each specific intended use.
- **THE NOTIFIED BODY IS GIVEN THE RESPONSIBILITY** of carrying out an initial evaluation of the manufacturer, certifying the production system and/or the product, and keeping an effective periodic verification plan active.

ENVIRONMENTAL IMPACT CHARACTERISTICS



THE ELEMENTS OF MARKING

EACH ROLL CONTAINS THE FOLLOWING INFORMATION (CONTAINED ON A LABEL, ON THE PACKAGING CONVEYORS, ON SILK-SCREEN PRINTED FILM, ETC...):

- CE symbol followed by the last two digits of the when it was applied for the first time;
- Product Certification number or FPC;
- product name;
- unique product identification code;
- reference to the performance declaration;
- length and width;
- weight or thickness;
- any performance Classes (for specific uses);
- declaration that hazardous substances are absent;
- identification number of the notified body.

Besides indications required by the CE Marking, the IMPER rolls are individually identified with the **QCT (Quality Control Ticket)** reference, which allows complete product traceability.

ROLL LABEL

PARAFLEX NT4 1

DoP: 0N4010-00

2

Q.C.T. **1434432815**

3

CARATTERISTICHE / SPECIFICATIONS
DIMENSIONI / SIZE - 10,00 X 1,00 (-1%) m
SPESS. / THICKNESS - 4,00 (mm)

4

TIPO / TYPE: T

NON CONTIENE AMIANTO CATRAME N° ALTRE SOSTANZE PERICOLOSE
IN CONFORMITÀ ALLE DISPOSIZIONI NAZIONALI (1)(2)
(1) IN PRESENZA DI METODI DI PROVA RIMANDEZZATI SU BASE LA VERIFICA
È LA DICHIARAZIONE SUI RILASCI/CONTENUTO DOVrà ESSERE FATTA
TENENDO CONTO DELLE DISPOSIZIONI NAZIONALI DEI PAESI DI DESTINAZIONE
FREE FROM COAL TAR, ASBESTOS AND OTHER DANGEROUS SUBSTANCES
IN ACCORDANCE WITH THE NATIONAL PROVISIONS (1)(2)
(2) IN THE ABSENCE OF EUROPEAN HARMONIZED TEST METHODS,
VERIFICATION AND DECLARATION ON RELEASE/CONTENT HAS TO BE DONE
TAKING INTO ACCOUNT NATIONAL PROVISIONS IN THE PLACE OF USE

5

CE

EN13787 (AVCP 2+)
1370 - CPD 0054
EN13969 (AVCP 2+)
1370 - CPD 0054

IMPER ITALIA
impermeabilità, protezione, ripristino
Via Volte, s.n. 18071 Fraz. Mezzano
Borghetto Tarone (TO)
www.imper.it combu2@imper.it

- 1 ▶ Product Name
- 2 ▶ N. of quality control ticket (QCT)
- 3 ▶ Roll dimensions and weight/thickness
- 4 ▶ Declaration that hazardous substances are absent
- 5 ▶ CE Symbol and reference standards for fields of use

PALLET LABEL

PRODOTTO/PRODUCT
PARALON NT4 PLUS 1

DIMENSIONI / SIZE
10.000M x 1.000(-1%) 2

FINITURA SUPERIORE SPESSORE/THICKNESS
TALCATA 4 mm 3

FINITURA INFERIORE
TERMOTENE 3

NON CONTIENE CATRAME, AMIANTO O ALTRE SOSTANZE PERICOLOSE
FREE FROM COAL TAR, ASBESTOS AND OTHER DANGEROUS SUBSTANCES

NR ROTOLI PER PALLET NR PALLET
NR ROLLS PER PALLET 4

20 - **1-00378772**

INFORMAZIONI PER I CLIENTI/CUSTOMER INFORMATION
CONSERVARE IN POSIZIONE VERTICALE, AL RIPARO DAL SOLE E DAL GELO
STABILIZZARE 24H A +5°C PRIMA DELL'USO
STOCK IN VERTICAL POSITION, SHELTER FROM SUN AND FREEZE.
STABILIZE 24HR AT +5°C BEFORE TC USE

CLIENTE/CUSTOMER

13
EN13707 (System 2+)
1370 - CPD 0054
EN13969 (System 2+)
1370 - CPD 0054

IMPER ITALIA
impermeabilità, protezione, ripristino

- 1 ▶ Product Name
- 2 ▶ Dimensions and weight
- 3 ▶ Upper/lower finish and roll thickness
- 4 ▶ N. rolls per pallet and N. pallet

ACCOMPANYING TECHNICAL DOCUMENT (ATD)

The Accompanying Technical Document (ATD) synthetically summarises a complete series of information on the product delivered and its correct use.

- **CONTAINING** a brief description of the membrane and the most important technical characteristics.
- **INDICATING** the installation methods.
- **SPECIFYING** the fields of use.
- **HAVING** the CE Mark and the last two digits of the year the mark is applied, along with reference to the Notified Body issuing the CE Certificate.



DECLARATION OF PERFORMANCE (DoP)

It describes performance of the products to be built in relation to their essential characteristics, as defined in the harmonised reference standards. The DoP (Declaration of Performance) replaces the conformity declaration previously foreseen by Directive 89/106/EEC and accompanies each product supplied, where even the information contained in the ATD is integrated into a single document.



MANUFACTURER RESPONSIBILITY

- **ORGANISING** and maintaining efficient a production control system (FPC).
- **CHARACTERISING** the product with initial type tests (ITT).
- **CARRYING OUT** periodic verifications according to a specific test plan.
- **DRAFTING** the protection declaration and placing the CE Marking.

RESPONSIBILITY OF THE NOTIFIED BODY

- **CARRYING OUT** any initial testing directly (based on reference standards).
- **CERTIFYING** the production control system.
- **CARRYING OUT** supervision of the control system.

USER RESPONSIBILITY

- **CHOOSING** the membrane suitable for the use foreseen based on the intended use indicated by the manufacturer.
- **MAKING SURE** that the material received is duly marked CE.

PRODUCTS

THE BITUMINOUS SECTOR OFFERS THE MARKET A WIDE RANGE OF WATERPROOFING PRODUCTS: FROM THE POLYMER DISTILLED BITUMEN PREFABRICATED MEMBRANES, TO THE SYNTHETIC LIQUID WATERPROOFING SUBSTANCES, TO BITUMEN EMULSIONS, TO INSULATING SYSTEMS, COUPLED WITH COMPLEMENTARY PRODUCTS, ETC.

● (MBDP) POLYMER DISTILLED BITUMEN MEMBRANE

There are always more and more Countries where the legislation foresees the use of materials with technical characteristics and specific performance, controlled and certified by official Institutions.

A significant quantity of membranes of the BITUMEN SECTOR has such recognitions, referred to product quality, obtained in different Countries of the world.

The membranes are made in the production facility of the IMPER Sector, certified as compliant with ISO 9001 standard that ensures the quality of production processes. The variety of prefabricated polymer distilled bitumen membranes includes:

- **membranes with plastomeric based compound** (Atactic Polypropylene APP) of the black type self-protecting with mineral slate flakes, reinforcing mat made in "*non-woven fabric*" made of polyester, even stabilised, or "*glass fibre*";
- **membranes with elastomeric-based compound** (Styrene - Butadiene - Styrene: SBS) in the black and self-protective types with mineral slate flakes, or metal blades, reinforcing mat in polyester "*non-woven fabric*" or "*glass fibre*";
- **membranes with elastoplastomeric PARALLOY® compound** with metallocene resin base that is similar to the best characteristics of the SBS and APP compounds. Two series of products are made with this compound: PARALON^{PLUS} and PARALON^{PLUS} FIRE. The latter contains the PARALLOY® additive, with special substances that give the membrane particular self-extinguishing and fire resistant properties. The co-extruded reinforcing mat is made of polyester "*non-woven fabric*", duly compatibilised, or "*non-woven fabric*" made of stabilised polyester.

They are in the black and self-protective with mineral slate flakes type.

● RECOMMENDED USES

THE RANGE COVERS ALL WATERPROOFING NEEDS:

- roofs of any type;
- foundations and walls against the ground;
- decks, bridges, viaducts;
- basins, channels, water works;
- roof gardens, balconies-parking lots;
- top surfaces of artificial tunnels;
- inverted roofs;
- etc...

In the following pages only a few of the membranes of current production and other numerous products that are successfully made for Italy and overseas markets.

● OTHER PRODUCTS

Protective paints for waterproofing surfaces, synthetic waterproofing liquids, bitumen emulsions and solutions, products for protection and drainage, special adhesives, primers, insulating thermal material coupled and not, the bituminous tiles complete the range of the BITUMEN SECTOR, confirming their specialisation.

The characteristics of each product, summarised in tables, make it possible to perceive the completeness and the level of specialisation.

Specific documentation is available to complete all information requirements.



PARALON^{PLUS} SERIES

The PARALON family has been available on the market for 45 years. Along with the unique technical characteristics, that make PARALON^{PLUS} **reliable in terms of performance and duration**, the ITC Agreement, has issued certification and validity of the PARALON^{PLUS} series, articulated with different versions suitable for the most varied design and application needs, they are produced with classic, talc or slated surfaces and with TEXTENE[®] finish.

- The first Agrément referred to an entire series of products, the PARALON^{PLUS} range, instead of a single product.
- The first Agrément referred to fire performance.
- The first Agrément certifying product versions with different types of reinforcing mat: classic polyester from continuous thread, polyester from stabilised continuous thread, composite.
- The first Agrément certifying thicknesses that are both 3 mm and 4 mm.

The products of the PARALON^{PLUS} series are obtained by co-extrusion of a compound called PARALLOY[®], with metal-locene resin base with selected molecular weight, dispersed in distilled bitumen and "non-woven fabric" reinforcement made in continuous thread polyester, in certain products stabilised with glass fibres, duly compatibilised.

The lower face is protected by TERMOTENE[®] hot melt film that improves application and adhesion to the support to be water-proofed.

The PARALLOY[®] compound summarises the best characteristics of SBS and APP compounds.



THE CURRENT PARALON^{PLUS} FAMILY IS AVAILABLE IN THE FOLLOWING PRODUCTS:

- PARALON NT^{PLUS} ST
- PARALON ARD/HS^{PLUS} ST
- PARALON ARD/HS^{PLUS} ST FIRE
- PARALON ARD/S^{PLUS} ST FIRE
- PARALON ANTI-ROOT
- PARALON COLD
- PARALON FIRE COLD
- PARALON COLD HP
- PARALON COLD HP AR
- PARALON^{PLUS} MS

CERTIFICATIONS

Constant verifications conducted by UEAtc Institutes on the products with Agrément and Certifications of International Institutes, along with strict quality controls of the IMPER Sector that works for quality assurance and management according to the ISO 9001 standard, guaranteeing high level performance and aesthetic standard of PARALON^{PLUS} and certify their reliability and long duration.

The PARALON^{PLUS} FIRE products are certified by the Belgian Institute UBAtc, according to the EN 1187-1 European standard.

The black membranes of the PARALON^{PLUS} series can be supplied with the talc upper face as well as with the TEXTENE[®] finish that significantly improves all characteristics of the very membranes.

Agrément UEAtc:



International certifications:



MIXTURE

This is the waterproofing part of the product. It is called mixture because it is a special formula of selected bitumen and particular polymers. The different types of mixture differ mainly because of the type of polymer used.

THE MAIN POLYMERS ARE:

- **SBS** - These give the mixture characteristics of optimal workability at low temperatures, great resistance to mechanical stress and optimal elastic behaviour. The SBS mixtures are also called ELASTOMERIC. They have the limit of not being stable at high temperatures and they are not resistant to U.V. rays.
- **APP** - These give the mixture optimal resistance to U.V. rays and optimal stability to high temperatures. The APP mixtures are also called PLASTOMERIC. Their limit is that they are less elastic and less flexible at low temperatures.

The evolution of polymers has led to the creation of mixtures referred to as ELASTOPLASTOMERIC that summarise the best characteristics of SBS and APP polymers, in fact these mixtures are heat resistant, stable to U.V. rays, elastic and flexible even at low temperatures.

REINFORCEMENT

This is the internal part of the membrane that supports the mixture.

THEY CAN BE:

- **GLASS FIBRE**
They provide dimensional stability and non-degradable quality to the product (VV).
- **POLYESTER STAPLE FABRIC**
They provide good mechanical resistance (NT).
- **CONTINUOUS THREAD POLYESTER**
They provide the best mechanical properties to the product (FC).
- **STABILISED**
All polyester reinforcements can be reinforced with glass fibres to improve the stability characteristics of the product even more (NT/ST and FC/ST).

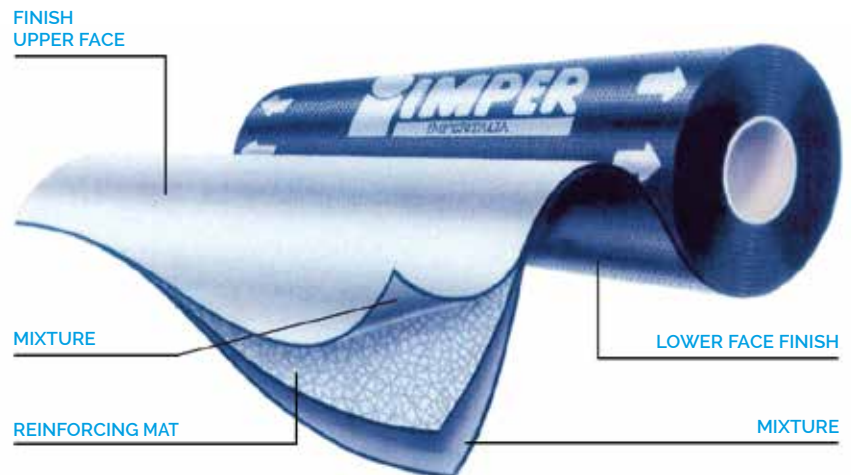

HOW TO CHOOSE A GOOD POLYMER DISTILLED BITUMEN MEMBRANE?

The polymer bitumen membranes, besides the previous characteristics, also differentiate based on two determining factors: weight/thickness and cold flexibility:

- **WEIGHT/THICKNESS:** The slated polymer bitumen membranes are identified by their weight (density) and can be 3.5 kg, 4 kg, or 4.5 kg per m².
The black membranes are identified based on their standardised 3 mm or 4 mm thickness. They can also be supplied with a weight of 3 kg or 4 kg. Thickness is a quality index for the product.
- **COLD FLEXIBILITY:** This summarises the characteristics of the mixture based on standardised laboratory tests (UNI-EN 1109).
It does not, in any way, indicate product installation temperature nor its operating temperature.
It is a quality index for the product.
(For example: -10°C is better than 0°C).

THE POLYMER DISTILLED BITUMEN MEMBRANES CAN BE FINISHED ON THE UPPER AND LOWER SURFACE, BASED ON THE PRODUCT AND THE REQUIREMENTS, WITH VARIOUS TREATMENTS.

SLATED UPPER FINISH



GREY SLATE



RED SLATE



GREEN SLATE



WHITE SLATE

SLATING - Self-protecting treatment achieved by adhesion to the upper surface of the membrane of natural mineral slate flakes, during the manufacturing process, and prefixed and controlled granulometry. The mineral pigments adopted for the realisation of the available shades are fixed with a particular ceramisation procedure. The standard colours are: natural grey, red, green and natural white. (Other colours upon request*).

(* Upon request, it is available in the reflecta white mineral slate flakes.

UPPER FINISH



TEXTENE®



WITH SAND

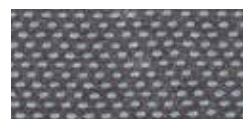

TERMOTENE®



BLACK HDPE FILM



GLOSSY POLYPROPYLENE

TEXTENE® - Finishing treatment, with high value added, obtained through a special procedure based on a textured polymeric fibre layer, preformed in film, applied to the surface. The treatment is usually carried out on the upper surface of the membrane, in certain cases it is done on the upper and lower surface.

THE TREATMENT IMPROVES:

- **The aesthetic point of view** - The surface of the membrane takes on greater regularity and offers a smooth sensation to the touch;
- **The ecological point of view** - Absence of talc allows better cleaning during installation operations and avoids releasing powder substances into the environment;
- **Performance point of view** - The treatment enriches the technical profile of the membrane with particular attention to waterproofing duration, weldability of the sheets, their compactness and shearing resistance, to practicability of the surface and its paintability.

LOWER FINISH



TERMOTENE®

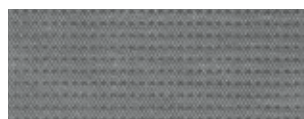

TEXTENE®



GREY SILICONISED FILM



GLOSSY POLYPROPYLENE

TERMOTENE® - Thermoplastic film the use of which, combined with the membrane, has been patented by IMPER ITALIA since 1977. The treatment is usually carried out on the lower surface of the membrane, in certain cases it is adopted on the lower and upper surface.

QUALITY OF THE TREATMENT:

- **easy** roll unwinding;
- **improves** adhesion of the membrane to the substrate;
- **reduces** the quantity of gas necessary to melt the mixture;
- **improves cleaning and safety conditions of the construction sites** (eliminating polyethylene non-stick sheets, reducing surface talc).

INTENDED USE OF THE MEMBRANES

Foreseen based on the AISPEC-SITEB-MBDP guidelines*

EXPOSED ROOFS

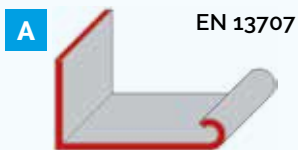

Exposed single ply

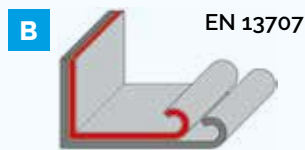

Multi-ply exposed systems Upper ply



Multi-ply exposed systems Lower ply

ROOFING UNDER HEAVY PROTECTION

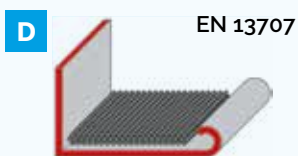

Single ply under heavy protection

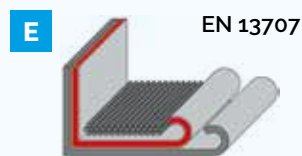

Multi-ply under heavy protection

GARDEN ROOFING

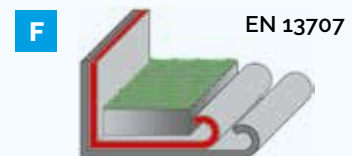

Anti-root Upper ply

UNDER ROOF TILE



Under roof tile

VAPOUR CONTROL

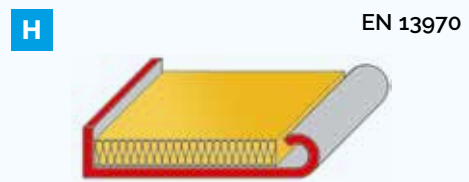

Shield or vapour barrier

FOUNDATIONS

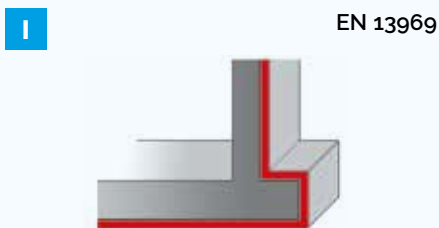

Foundations and walls against the ground

BRIDGES AND VIADUCTS

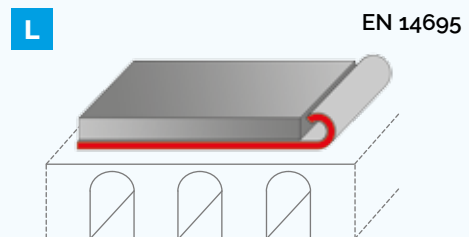

Waterproofing under bituminous conglomerate

* (For specifics regarding systems that can be made, consult technical services of Imper Italia Srl).

HOW TO INSTALL CORRECTLY A POLYMER DISTILLED BITUMEN MEMBRANE

PREPARE ALL SHEETS necessary for placing the layer, considering that they must overlap each other by 8 to 10 cm on the long side (longitudinal) and 12 to 15 cm for the short side (transversal). (See figure 1).

SHEET PLACEMENT must always start from the lowest point (compared to the slope) of the laying plane, proceeding with "roof tile" placement. It is good practice to make sure that the "head" joints (the ones on the short side) are staggered. Avoid "cross" joints. (See figure 2).

BONDING BY HEAT FUSION must always: be total at the joints (the overlap line); along the external perimeter of the entire layer (width of 100 cm) and on the trim areas for areas jutting out (e.g. chimneys) or built-in (e.g. drain unions); for the remaining parts of the laying surface (running parts) it can

be glued only in points, or completely gluing of all sheets in relation to the slope of the laying surface and the stress that the waterproofing surface will be subject to.

THE BURNER FLAME must be mainly aimed at the contact area between the roll and the laying surface and not directly on the lower face of the membrane to be glued to the same laying surface. When carrying out joints, it is best to heat both the membrane and the trowel simultaneously.

THE LAYING SURFACE must be as flat as possible, smooth, without non-sticking parts, ruggedness, depressions, holes and it must be dry. It must also be sloped to ensure regular water flow to the drainage collection points. All corners must be rounded using concrete shells or pre-fabricated profiles made of a suitable material.

ON THE DUSTED SUBSTRATE one must lay the primer (IMPETENE PRIMER, PRIMER BIT or PRIMER WB) to ensure adhesion. The primer must dry completely (1-3 hours) before proceeding with application of the polymer bitumen membranes.

WHEN CARRYING OUT THE SURFACE WITH MEMBRANES THAT ARE NOT SELF-PROTECTED, it is recommended to paint it with two crossed coats of a protective formula, choosing between SAVANA PAINT, LAMPROS BIT and BIVERALL, according to instructions from the related technical data sheets. These protections preserve their effectiveness for 3-5 years depending on the climate to which they are exposed.

IT IS RECOMMENDED TO PLAN FOR PERIODIC MAINTENANCE OF THE SURFACE. Any surfaces that do not have the proper slope for normal water flow cannot be painted with SAVANA PAINT.

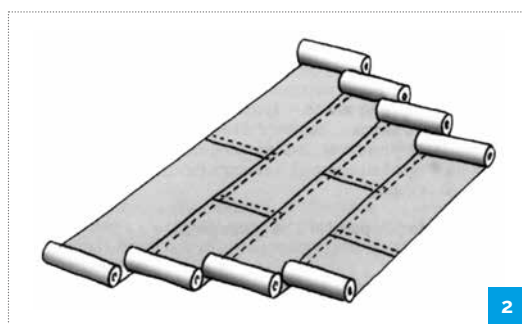
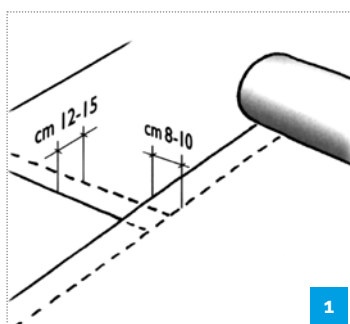

STORAGE

The rolls must always be stored vertically. Do not overlay more than 2 pallets, making sure that a rigid dividing panel is placed in-between (avoid overlaying thin SBS or MBDP pallets).

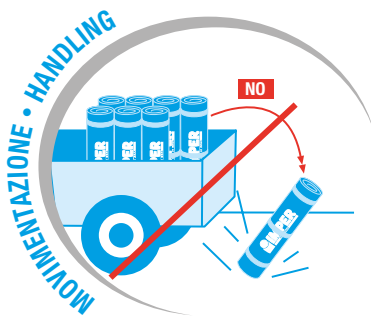
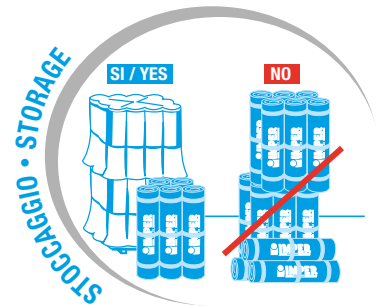

HANDLING

The loading and unloading of the rolls must be carried out using the necessary precautions, without overturning.

PROTECTION

Possibly store the rolls protected from the sun and the weather.

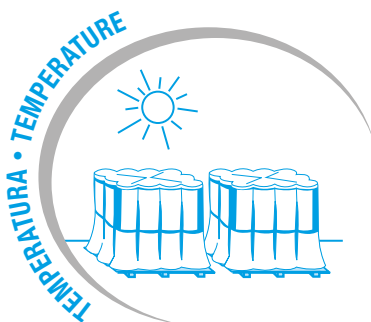
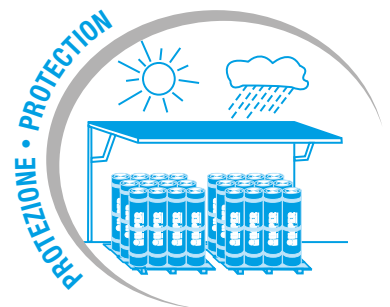

CONSTRUCTION SITE

Adopt suitable precautions when handling pallets with a crane. (Weighing about 1000 kg).

TEMPERATURE

Make horizontal and vertical cuts to the heat-shrink cap to air out the pallets if stored, even briefly, under the sun.





TERMOTENE

TERMOTENE

TERMOTENE

TERMOTENE

TERMOTENE

ARD/S PLUS 4,5

5 kg/mq IMPER PARALON

IMPER PARAGUM NT

Agreement USAItc IMPER PARAGUM NT

NT

ITALIA
IMPER
MEMBER OF CHROMICOL CORPORATION
Bituminous waterproofing systems

ARD / S IMPER ARD

ITALIA
IMPER
MEMBER OF CHROMICOL CORPORATION
Bituminous waterproofing systems

ARD / S IMPER ARD

since 1936
80 YEARS OF EXPERIENCE

ARD / S

PARALON

4,5 kg/mq IMPER

POLIESTERE

POLIESTERE

TERMOTENE

TERMOTENE







TERMOTENE

TERMOTENE

> PARAFLEX -25°C CE

Elastomer polymer distilled bitumen waterproofing membranes (SBS).

The NT version has a "non-woven fabric" reinforcing mat made in polyester from continuous thread stabilised using mineral fibres, while the W version has "glass fibre" reinforcement.







PRODUCT	WEIGHT THICKNESS	FINISH UPPER	FINISH LOWER	REINFORCING MAT	SIZE ROLL (M)	ROLLS FOR PALLET (N.)	FIELDS (*) OF USE
PARAFLEX NT	3 mm	PP Film	PP Film	FC/ST	10 x 1	25	C-E-I
	4 mm	PP Film (●) (●)	PP Film (●)	FC/ST	10 x 1	20	C-D-E-I-L
PARAFLEX ARD/HS	4mm+ard		PP Film	FC/ST	8 x 1	20	A-B-G
	4mm+ard	   (*)	PP Film	FC/ST	8 x 1	20	A-B-G
PARAFLEX ARD/S	4.5 kg		PP Film	FC/ST	10 x 1	20	B-G
	4.5 kg	  (*)	PP Film	FC/ST	10 x 1	20	B-G
PARAFLEX W	3 mm	PP Film	PP Film	WV	10 x 1	25	C
	4 mm	PP Film	PP Film	WV	10 x 1	20	C

(●) Also available with Textene® finish with the addition of 0.12 €/m². (●) Also available with double Textene® (D-TEX) finish with the addition of 0.60 €/m². (*) Minimum order approx. 1000 m².

> TECNOFLEX -20°C CE

Elastomer polymer distilled bitumen waterproofing membranes (SBS).

The NT version has a "non-woven fabric" reinforcement made in polyester from continuous thread, while the W version has "glass fibre" reinforcement.

PRODUCT	WEIGHT THICKNESS	FINISH UPPER	FINISH LOWER	REINFORCING MAT	SIZE ROLL (M)	ROLLS FOR PALLET (N.)	FIELDS (*) OF USE
TECNOFLEX NT	3 mm	PP Film	PP Film	FC	10 x 1	25	C-E-I
	4 mm	PP Film	PP Film	FC	10 x 1	20	C-D-E-I
TECNOFLEX NT/ARD	4 kg		PP Film	FC	10 x 1	25	B-G
	4.5 kg	   (*)	PP Film	FC	10 x 1	20	B-G
	4 kg		PP Film	FC	10 x 1	25	B-G
	4.5 kg	  (*)	PP Film	FC	10 x 1	20	B-G

(*) Minimum order approx. 1000 m².





> BITEXTENE FLEX MT -20°C CE

Pre-fabricated waterproofing membranes obtained through co-extrusion of a special elastomeric mixture obtained by complex dispersion of rubbers and elastophenic copolymers and a reinforcing mat of "non-woven fabric" from stabilised polyester.

Particularly indicated when optimal adhesion to the substrate is needed. Both surfaces are finished with the TEXTENE® treatment.

PRODUCT	WEIGHT THICKNESS	FINISH UPPER	FINISH LOWER	REINFORCING MAT	SIZE ROLL (M)	ROLLS FOR PALLET (N.)	FIELDS (*) OF USE
BITEXTENE FLEX MT	3 mm	Textene	Textene	NT/ST	10 x 1	25	C-E-I
	4 mm	Textene	Textene	NT/ST	10 x 1	20	B-C-D-E-I

(●) Also available with textene® finish with the addition of 0.12 €/m². (●) Also available with double textene® (D-TEX) finish with the addition of 0.60 €/m². (*) Minimum order approx. 1000 m².

> TEXTENE FLEX -20°C CE

Pre-fabricated waterproofing membranes obtained by co-extruding a special elastomeric polymer distilled bitumen based compound with high performance level and a "non-woven fabric" reinforcing mat made of stabilised polyester.









The upper face is finished using the TEXTENE® treatment.

PRODUCT	WEIGHT THICKNESS	FINISH UPPER	FINISH LOWER	REINFORCING MAT	SIZE ROLL (M)	ROLLS FOR PALLET (N.)	FIELDS (*) OF USE
TEXTENE FLEX	3 mm	Textene	PP Film	NT/ST	10 x 1	25	C-E-I
	4 mm	Textene	PP Film	NT/ST	10 x 1	20	B-C-D-E-I

(*) Minimum order approx. 1000 m².

> STAR -18°C CE

Pre-fabricated waterproofing membranes obtained by co-extruding a bitumen dispersion of micro compatibilising agents in an elastophinic polymer matrix and a "non-woven fabric" reinforcing mat made of dimensionally controlled stabilised polyester with mineral fibres positioned longitudinally.

PRODUCT	WEIGHT THICKNESS	FINISH UPPER	FINISH LOWER	REINFORCING MAT	SIZE ROLL (M)	ROLLS FOR PALLET (N.)	FIELDS (*) OF USE
STAR	3 mm	With sand	Textene	NT/ST	10 x 1	25	C-E-I
	4 mm	With sand	Textene	NT/ST	10 x 1	20	B-C-D-E-I
STAR TEXTENE	3 mm	Textene	Textene	NT/ST	10 x 1	25	C-E-I
	4 mm	Textene	Textene	NT/ST	10 x 1	20	C-E-I
STAR TEXTENE	4 kg		Textene	NT/ST	10 x 1	25	B-G
	4.5 kg	   (*)	Textene	NT/ST	10 x 1	20	B-G
STAR ARD	4 kg		Textene	NT/ST	10 x 1	25	B-G
	4.5 kg	   (*)	Textene	NT/ST	10 x 1	20	B-G

(*) Minimum order approx. 1000 m².

BENEFITS

- High adhesion level of the **STAR** membranes, they are characterised by a high level of adhesion that allows greater anchoring to the substrate and greater seal of the junction between sheets.
- High elasticity.
- Flexibility at low temperatures.
- Resistance to U.V. rays.
- Lightweight and easy installation.
- Appealing aspect.



> LEVIFLEX -5/-10/-15/-20°C CE

Light waterproofing membranes obtained by co-extrusion of a polymer distilled bitumen compound and micro compatibilising agents made using particular dosing and dispersion systems, and a polyester reinforcing mat, both "non-woven fabric" and continuous thread with dimensional stability controlled using longitudinally positioned mineral fibres.

PRODUCT	WEIGHT THICKNESS	FINISH UPPER	FINISH LOWER	REINFORCING MAT	SIZE ROLL (M)	ROLLS FOR PALLET (N.)	FIELDS (*) OF USE
LEVIFLEX 20	3 mm	With sand	Termotene	FC/ST	10 x 1	25	C-E-I
	4 mm	With sand	Termotene	FC/ST	10 x 1	23	B-C-E-I
LEVIFLEX 20 ARD	4.5 kg		Termotene	FC/ST	10 x 1	18	B-G
	4.5 kg	(*)	Termotene	FC/ST	10 x 1	18	B-G
LEVIFLEX 15	3 mm	With sand	Termotene	FC/ST	10 x 1	25	C-E-I
	4 mm	With sand	Termotene	FC/ST	10 x 1	23	B-C-E-I
LEVIFLEX 15 ARD	4.5 kg		Termotene	FC/ST	10 x 1	18	B-G
	4.5 kg	(*)	Termotene	FC/ST	10 x 1	18	B-G
LEVIFLEX 10	3 mm	With sand	Termotene	FC/ST	10 x 1	25	C-E-I
	4 mm	With sand	Termotene	FC/ST	10 x 1	23	B-C-E-I
LEVIFLEX 10 ARD	4.5 kg		Termotene	FC/ST	10 x 1	18	B-G
	4.5 kg	(*)	Termotene	FC/ST	10 x 1	18	B-G
LEVIFLEX 5	3 mm	With sand	Termotene	FC/ST	10 x 1	25	C-E-I
	4 mm	With sand	Termotene	NT/ST	10 x 1	23	B-C-E-I
LEVIFLEX 5 ARD	4.5 kg		Termotene	NT/ST	10 x 1	18	B-G
	4.5 kg	(*)	Termotene	NT/ST	10 x 1	18	B-G

(*) Minimum order approx. 1000 m².

BENEFITS







- Lightness.
- Dimensional stability.
- High level of adhesion.
- High level of elasticity.
- Quicker installation.
- Less gas consumption.
- The LEVIFLEX membranes are suitable for various types of waterproofing works.



> PARALON PLUS ST -20°C CE

Pre-fabricated membranes for waterproofing that requires high levels of mechanical resistance.

They are obtained by co-extruding the PARALLOY® compound based on metallocene resin with selected molecular weight dispersed in bitumen, and a reinforcing mat of "non-woven fabric" made with continuous thread with dimensional stability controlled using longitudinally positioned mineral fibres.













PRODUCT	WEIGHT THICKNESS	FINISH UPPER	FINISH LOWER	REINFORCING MAT	SIZE ROLL (M)	ROLLS FOR PALLET (N.)	FIELDS (*) OF USE
PARALON NT4 PLUS	3 mm	With sand (●)	Termotene	FC/ST	10 x 1	20	A-B-C-D-E-I-L
	4 mm	With sand (●)	Termotene	FC/ST	8 x 1	20	A-B-C-D-E-I-L
PARALON ARD/HS PLUS ST	4mm+ard		Termotene	FC/ST	10 x 1	18	A-B-G
	4mm+ard		Termotene	FC/ST	10 x 1	18	A-B-G
	4mm+ard	 (*)	Termotene	FC/ST	10 x 1	18	A-B-G
PARALON ARD/S PLUS ST	4.5 kg		Termotene	FC	10 x 1	20	B-G
	4.5 kg		Termotene	FC	10 x 1	20	B-G
	4.5 kg	 (*)	Termotene	FC	10 x 1	20	B-G

(●) Also available with textene® finish with the addition of 0.12 €/m². (*) Minimum order approx. 1000 m².



> UNOSINT -20°C CE













Pre-fabricated waterproofing membranes obtained by co-extruding an elastoplastomeric polymer distilled bitumen based compound with a "non-woven fabric" reinforcing mat made of continuous thread polyester.

PRODUCT	WEIGHT THICKNESS	FINISH UPPER	FINISH LOWER	REINFORCING MAT	SIZE ROLL (M)	ROLLS FOR PALLET (N.)	FIELDS (*) OF USE
UNOSINT	3 mm	With sand (•)	Termotene	FC	10 x 1	25	C-E-I
	4 mm	With sand (•)	Termotene	FC	10 x 1	20	B-C-E-I
UNOSINT ARD	4 kg		Termotene	FC	10 x 1	25	B-G
	4.5 kg		Termotene	FC	10 x 1	20	B-G
	4mm+ard		Termotene	FC	10 x 1	20	B-G
	4 kg	   (*)	Termotene	FC	10 x 1	25	B-G
	4.5 kg	   (*)	Termotene	FC	10 x 1	20	B-G
	4mm+ard	   (*)	Termotene	FC	10 x 1	20	B-G

(•) Also available with textene® finish with the addition of 0.12 €/m². (*) Minimum order approx. 1000 m².

> SINTOPLENE -15°C CE

Pre-fabricated waterproofing membranes obtained by co-extruding an elastoplastomeric polymer distilled bitumen based compound with a "non-woven fabric" reinforcing mat made of continuous thread polyester.









PRODUCT	WEIGHT THICKNESS	FINISH UPPER	FINISH LOWER	REINFORCING MAT	SIZE ROLL (M)	ROLLS FOR PALLET (N.)	FIELDS (*) OF USE
SINTOPLENE	3 mm	With sand (•)	Termotene	FC	10 x 1	25	C-E-I
	4 mm	With sand (•)	Termotene	FC	10 x 1	20	B-C-E-I
SINTOPLENE ARD	4 kg		Termotene	FC	10 x 1	25	B-G
	4.5 kg		Termotene	FC	10 x 1	20	B-G
	4mm+ard		Termotene	FC	10 x 1	20	B-G
	4 kg	   (*)	Termotene	FC	10 x 1	25	B-G
	4.5 kg	   (*)	Termotene	FC	10 x 1	20	B-G
	4mm+ard	   (*)	Termotene	FC	10 x 1	20	B-G

(•) Also available with textene® finish with the addition of 0.12 €/m². (*) Minimum order approx. 1000 m².



> PARAGUM ST -15°C CE

















Pre-fabricated waterproofing membranes obtained by co-extruding an elastoplastomeric polymer distilled bitumen based compound with a "non-woven fabric" reinforcing mat made of continuous thread polyester stabilised using glass fibres.

PRODUCT	WEIGHT THICKNESS	FINISH UPPER	FINISH LOWER	REINFORCING MAT	SIZE ROLL (M)	ROLLS FOR PALLET (N.)	FIELDS (*) OF USE
PARAGUM ST	3 mm	With sand	Termotene	FC/ST	10 x 1	25	B-C-E-I
	4 mm	With sand	Termotene	FC/ST	10 x 1	20	A-B-C-D-E-I
PARAGUM ST ARD/S	4.5 kg		Termotene	FC/ST	10 x 1	20	B-G
	4.5 kg	   (*)	Termotene	FC/ST	10 x 1	20	B-G
PARAGUM ST ARD/HS	4mm+ard		Termotene	FC/ST	10 x 1	18	A-B-G
	4mm+ard	   (*)	Termotene	FC/ST	10 x 1	18	A-B-G

(*) Minimum order approx. 1000 m².

> TOP -10°C CE









Pre-fabricated waterproofing membranes obtained by co-extruding an elastoplastomeric polymer distilled bitumen based compound with a "non-woven fabric" reinforcing mat made of continuous thread polyester stabilised using glass fibres.

PRODUCT	WEIGHT THICKNESS	FINISH UPPER	FINISH LOWER	REINFORCING MAT	SIZE ROLL (M)	ROLLS FOR PALLET (N.)	FIELDS (*) OF USE
TOP S	3 mm	With sand (●)	Termotene	FC/ST	10 x 1	25	C-E-I
	4 mm	With sand (●)	Termotene	FC/ST	10 x 1	20	B-C-E-I
TOP ARD/S	4 kg		Termotene	FC/ST	10 x 1	25	B-G
	4.5 kg		Termotene	FC/ST	10 x 1	20	B-G
	4 kg	   (*)	Termotene	FC/ST	10 x 1	25	B-G
	4.5 kg	   (*)	Termotene	FC/ST	10 x 1	20	B-G
TOP N	3 mm	With sand	Termotene	VV	10 x 1	25	C
	4 mm	With sand	Termotene	VV	10 x 1	20	C
TOP ARD/N	4 kg		Termotene	VV	10 x 1	20	B-G
	4.5 kg		Termotene	VV	10 x 1	20	B-G
	4 kg	   (*)	Termotene	VV	10 x 1	20	B-G
	4.5 kg	   (*)	Termotene	VV	10 x 1	20	B-G

(●) Also available with textene® finish with the addition of 0.12 €/m². (*) Minimum order approx. 1000 m².

> CENTRO -10°C CE









Pre-fabricated waterproofing membranes obtained by co-extruding an elastoplastomeric polymer distilled bitumen based compound with a "non-woven fabric" reinforcing mat made of dimensional stability polyester controlled using longitudinally positioned glass fibres.

PRODUCT	WEIGHT THICKNESS	FINISH UPPER	FINISH LOWER	REINFORCING MAT	SIZE ROLL (M)	ROLLS FOR PALLET (N.)	FIELDS (*) OF USE
CENTRO	3 mm	With sand (•)	Termotene	NT/ST	10 x 1	25	C-E-I
	4 mm	With sand (•)	Termotene	NT/ST	10 x 1	23	B-C-E-I
CENTRO ARD	4 kg		Termotene	NT/ST	10 x 1	25	B-G
	4.5 kg		Termotene	NT/ST	10 x 1	20	B-G
	4 kg	   (*)	Termotene	NT/ST	10 x 1	25	B-G
	4.5 kg	   (*)	Termotene	NT/ST	10 x 1	20	B-G

(•) Also available with textene® finish with the addition of 0.12 €/m². (*) Minimum order approx. 1000 m².

> SINTOGUM -5°C CE

Pre-fabricated waterproofing membranes obtained by co-extruding an elastoplastomeric polymer distilled bitumen based compound with a "non-woven fabric" reinforcing mat made of stabilised polyester (SINTOGUM PE) or reinforced "glass fibres" (SINTOGUM W).

PRODUCT	WEIGHT THICKNESS	FINISH UPPER	FINISH LOWER	REINFORCING MAT	SIZE ROLL (M)	ROLLS FOR PALLET (N.)	FIELDS (*) OF USE
SINTOGUM PE	3 mm	With sand (•)	Termotene	NT/ST	10 x 1	25	C-E-I
	4 mm	With sand (•)	Termotene	NT/ST	10 x 1	23	B-C-E-I
SINTOGUM PE ARD	4 kg		Termotene	NT/ST	10 x 1	25	B-G
	4.5 kg		Termotene	NT/ST	10 x 1	23	B-G
	4 kg	   (*)	Termotene	NT/ST	10 x 1	25	B-G
	4.5 kg	   (*)	Termotene	NT/ST	10 x 1	23	B-G
SINTOGUM W	3 mm	With sand	Termotene	VV	10 x 1	25	C
	4 mm	With sand	Termotene	VV	10 x 1	23	C

(•) Also available with textene® finish with the addition of 0.12 €/m². (*) Minimum order approx. 1000 m².

> PARALON^{PLUS} ST FIRE -15°C

Pre-fabricated membranes for waterproofing that requires high levels of mechanical resistance.

They are obtained by co-extruding the PARALLOY[®] compound based on metallocene resin with selected molecular weight dispersed in bitumen, duly using special non-toxic substance additives and a reinforcing mat of "non-woven fabric" made with continuous polyester thread.

PRODUCT	WEIGHT THICKNESS	FINISH UPPER	FINISH LOWER	REINFORCING MAT	SIZE ROLL (M)	ROLLS FOR PALLET (N.)	FIELDS (*) OF USE
PARALON NT ^{PLUS} ST FIRE	3 mm	With sand	Termotene	FC/ST	10 x 1	25	C-E-I
	4 mm	With sand	Termotene	FC/ST	10 x 1	20	A-B-C-D-E-I
PARALON ARD/HS ^{PLUS} ST FIRE	4 mm+ard		Termotene	FC/ST	10 x 1	16	A-B-G
	4 mm+ard	(*)	Termotene	FC/ST	10 x 1	16	A-B-G
PARALON ARD/S ^{PLUS} ST FIRE	4.5 kg		Termotene	FC/ST	10 x 1	20	B-G
	4.5 kg	(*)	Termotene	FC/ST	10 x 1	20	B-G

(*) Minimum order approx. 1000 m².

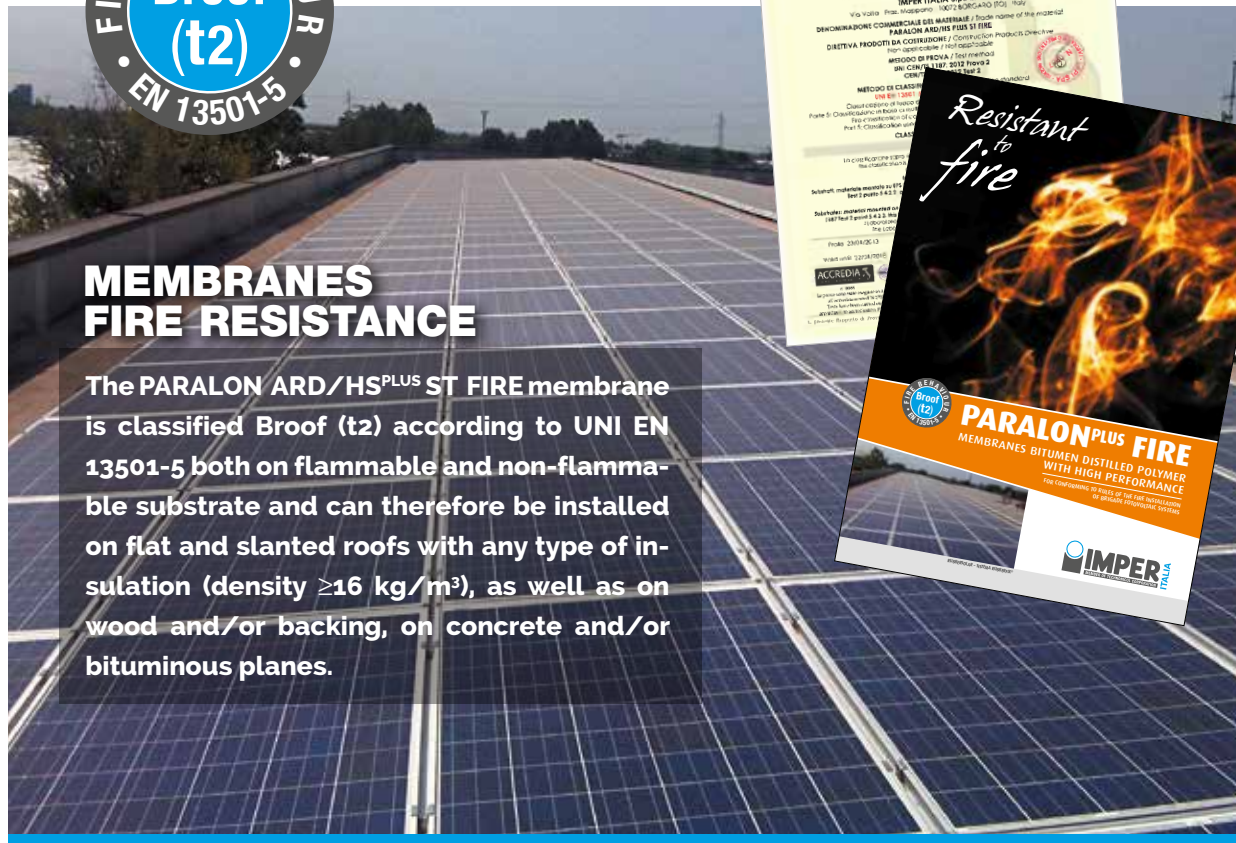

MEMBRANES FIRE RESISTANCE

The PARALON ARD/HS^{PLUS} ST FIRE membrane is classified Broof (t2) according to UNI EN 13501-5 both on flammable and non-flammable substrate and can therefore be installed on flat and slanted roofs with any type of insulation (density ≥ 16 kg/m³), as well as on wood and/or backing, on concrete and/or bituminous planes.

(*) See key on page 17. For a correct realisation of modular layers, contact our Technical Service. For technical characteristics, consult the specific data sheets for each product, published on the Internet site (www.imper.it).

> PARALON COLD SYSTEM -20°C

Innovative "cold" waterproofing system, made from special pre-fabricated membranes glued to the installation plane using special ADITHENE adhesive.

PRODUCT	WEIGHT THICKNESS	FINISH UPPER	FINISH LOWER	REINFORCING MAT	SIZE ROLL (M)	ROLLS FOR PALLET (N.)	FIELDS (*) OF USE
PARALON COLD	4 mm	With sand	Textene	FC/ST	10 x 1	20	A-B-C-E-I
PARALON FIRE COLD	4 mm	With sand	Textene	FC/ST	10 x 1	20	A-B-C-E-I
PARALON COLD HP	5 mm	With sand	Textene	FC/ST	10 x 1	16	A-B-C-D-E-I
PARALON COLD HP AR	5 mm	With sand	Textene	FC/ST	10 x 1	16	D-E-F-I

> ADITHENE

"Cold" bitumen based glue, elastomers, resins and particular solvent-based adhesive substances.

Ideal for cold gluing waterproofing membranes.

PRODUCT	WEIGHT THICKNESS	FINISH UPPER	FINISH LOWER
ADITHENE	25 kg can	1	1 x 33



WATERPROOFING SYSTEM
 ALSO SINGLE LAYER FOR COLD INSTALLATION

BITUMEN-POLYMER MEMBRANE
 +
BITUMEN-ELASTOMER GLUE

(*) See key on page 17. For a correct realisation of modular layers, contact our Technical Service. For technical characteristics, consult the specific data sheets for each product, published on the Internet site (www.imper.it).



> VAPOBAR -10°C CE

Pre-fabricated waterproofing membranes obtained by co-extrusion of a special vapour waterproof polymer distilled bitumen compound and a reinforcing mat made of an aluminium sheet and a "glass fibre".

PRODUCT	WEIGHT THICKNESS	FINISH UPPER	FINISH LOWER	REINFORCING MAT	SIZE ROLL (M)	ROLLS FOR PALLET (N.)	FIELDS (*) OF USE
VAPOBAR	2 kg	With sand	Termotene	AL/WV	20 x 1	20	H
	2 mm	With sand	Termotene	AL/WV	20 x 1	20	H
	3 mm	With sand	Termotene	AL/WV	10 x 1	20	H
	4 mm	With sand	Termotene	AL/WV	10 x 1	20	H

> ADEVAPOR 35 -15°C CE

Pre-fabricated membranes obtained by co-extrusion of a special compound, polymer distilled bitumen.

They are produced in the W, ST versions, respectively with "glass fibre" or stabilised polyester reinforced mat, or with reinforced "glass fibre" or stabilised polyester reinforcement mat, coupled with an aluminium sheet (vapour barrier).

PRODUCT	WEIGHT THICKNESS	FINISH UPPER	FINISH LOWER	REINFORCING MAT	SIZE ROLL (M)	ROLLS FOR PALLET (N.)	FIELDS (*) OF USE
ADEVAPOR 35 VV	3.5 mm	Textene	Termotene	VV	10 x 1	20	H
ADEVAPOR 35 ST	3.5 mm	Textene	Termotene	NT/ST	10 x 1	20	H
ADEVAPOR 35 AL	3.5 mm	Textene	Termotene	AL+VV	10 x 1	20	H



> PARALON ANTI-ROOT -20°C CE

Pre-fabricated membrane for waterproofing that requires high levels of mechanical resistance.

They are obtained by co-extruding the PARALLOY® compound based on metallocene resin with selected molecular weight dispersed in bitumen, using suitable additives with special chemical substances (fatty acids, phenoxide, esterified) that give the product a long-lasting anti-root effect, and a reinforcing mat of "non-woven fabric" made with continuous polyester thread.

PRODUCT	WEIGHT THICKNESS	FINISH UPPER	FINISH LOWER	REINFORCING MAT	SIZE ROLL (M)	ROLLS FOR PALLET (N.)	FIELDS (*) OF USE
PARALON ANTI-ROOT	4 mm	With sand	Termotene	FC/ST	10 x 1	20	F

> UNOSINT ANTI-ROOT -15°C CE

Pre-fabricated membrane obtained by co-extrusion of an elasto-plastomeric polymer distilled bitumen based compound, using suitable additives with special chemical substances (fatty acids, phenoxide, esterified) that give the product a long-lasting anti-root effect, and a reinforcing mat of "non-woven fabric" made with continuous polyester thread.

PRODUCT	WEIGHT THICKNESS	FINISH UPPER	FINISH LOWER	REINFORCING MAT	SIZE ROLL (M)	ROLLS FOR PALLET (N.)	FIELDS (*) OF USE
UNOSINT ANTI-ROOT	4 mm	With sand	Termotene	FC	10 x 1	20	F

> SINTOPLENE 3 AV -10°C

Pre-fabricated membrane from elasto-plastomeric polymer distilled bitumen based compound, with a reinforcing mat of "non-woven fabric" made with continuous polyester thread placed in the thickness of the membrane, in complete synergy with it.

Particularly recommended as a support layer for preparing waterproofing systems for road, railroad and overpass works.

PRODUCT	WEIGHT THICKNESS	FINISH UPPER	FINISH LOWER	REINFORCING MAT	SIZE ROLL (M)	ROLLS FOR PALLET (N.)	FIELDS (*) OF USE
SINTOPLENE 3 AV	3 mm	With sand	Termotene	FC	10 x 1	20	L

> UNOSINT 4/25 AV -15°C

Pre-fabricated membrane from elasto-plastomeric polymer distilled bitumen based compound, with a reinforcing mat of "non-woven fabric" made with continuous polyester thread weighing ≥ 250 g/m² placed in the thickness of the membrane, in complete synergy with it.

Thanks to its high mechanical resistance to punching and perforation, it is recommended for waterproofing road, railroad and overpass works.

PRODUCT	WEIGHT THICKNESS	FINISH UPPER	FINISH LOWER	REINFORCING MAT	SIZE ROLL (M)	ROLLS FOR PALLET (N.)	FIELDS (*) OF USE
UNOSINT 4/25 AV	4 mm	Textene	Termotene	FC	10 x 1	20	L

> THERMO STICKER PONTS HP -15°C

Pre-fabricated self-adhesive membrane obtained by co-extrusion layered with special compounds based on selected bitumen, modified with elasto-thermoplastic polymers and a reinforcing mat of "non-woven fabric" made with stabilised continuous polyester thread.

Recommended particularly for waterproofing road, railroad and overpass works with single-ply applications in direct contact with the hot laid bitumen conglomerate.

PRODUCT	WEIGHT THICKNESS	FINISH UPPER	FINISH LOWER	REINFORCING MAT	SIZE ROLL (M)	ROLLS FOR PALLET (N.)	FIELDS (*) OF USE
THERMO STICKER PONTS HP	2.5 mm	Textene	Siliconised Film	FC/ST	10 x 1	20	L



> SICURBAR -10°C CE

Pre-fabricated membrane with specific RADON gas resistance and impermeability characteristics.

PRODUCT	WEIGHT THICKNESS	FINISH UPPER	FINISH LOWER	REINFORCING MAT	SIZE ROLL (M)	ROLLS FOR PALLET (N.)	FIELDS (*) OF USE
SICURBAR	4 mm	With sand	Termotene	NT/ST	10 x 1	20	1

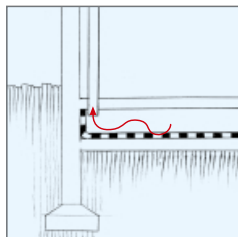
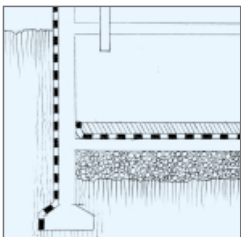
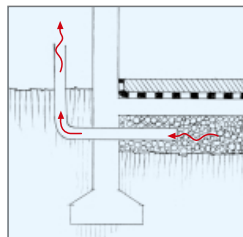
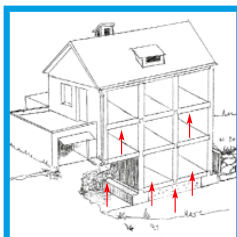

A few executions are illustrated in the following three examples.

BUILDING PROTECTION

The techniques for reducing Radon radiations are substantially of two types:

- Those that treat the residential unit.
- Those that treat the interface between the ground and the building.

PARTIAL ADHESION APPLICATION

> MULTIHOLES S/40 CE

Perforated membrane for connection layers for waterproofing systems in controlled semi-adherence, made of polymer distilled bitumen with reinforced "glass fibre" reinforced mat.

PRODUCT	WEIGHT THICKNESS	FINISH UPPER	FINISH LOWER	REINFORCING MAT	SIZE ROLL (M)	ROLLS FOR PALLET (N.)	FIELDS (*) OF USE
MULTIHOLES S/40	1 kg	Termotene	Termotene	VV	30 x 1	20	-

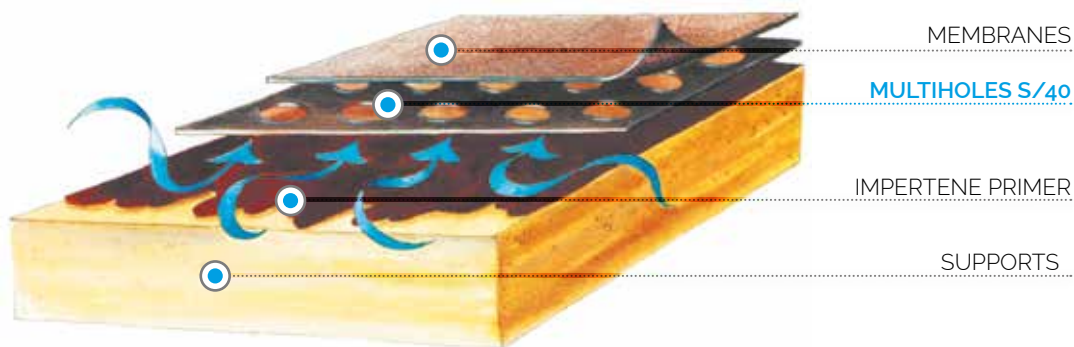

> PARAFLEX MS -25°C

Pre-fabricated membrane in elastomer polymer bitumen (SBS) produced by co-extrusion of a polyester "non-woven fabric" from continuous thread stabilised with mineral fibres and an innovative sealing mastic layered on the lower face, that gives the finished product remarkable adhesive characteristics on the installation surface and quick execution of flame sealed joints. Specification for restoring old bitumen waterproof surfaces in single-ply.

PRODUCT	WEIGHT THICKNESS	FINISH UPPER	FINISH LOWER	REINFORCING MAT	SIZE ROLL (M)	ROLLS FOR PALLET (N.)	FIELDS (*) OF USE
PARAFLEX MS	4 mm+ard		Termotene	FC/ST	8 x 1	20	A-B-G
	4 mm+ard		(*) Termotene	FC/ST	8 x 1	20	A-B-G

(*) Minimum order approx. 1000 m².

> PARALON PLUS MS -20°C

Pre-fabricated membrane for waterproofing that require high levels of mechanical resistance.

They are obtained by co-extrusion of the PARALLOY® compound based on metallocene resin base with selected molecular weight in bitumen. Specification for restoring old bitumen waterproof surfaces in single-ply.

PRODUCT	WEIGHT THICKNESS	FINISH UPPER	FINISH LOWER	REINFORCING MAT	SIZE ROLL (M)	ROLLS FOR PALLET (N.)	FIELDS (*) OF USE
PARALON PLUS MS	4 mm+ard		Termotene	FC/ST	8 x 1	18	A-B-G
	4 mm+ard		(*) Termotene	FC/ST	8 x 1	18	A-B-G

(*) Minimum order approx. 1000 m².



> STICKER HP -25°C CE

Pre-fabricated waterproofing membranes obtained by co-extrusion layered with special elastomeric-based compounds and particular adhesive additives.

The lower face of the membrane is protected by a grey silicone film that needs to be removed at the time of application. Available with the upper ply protected by a black coloured film (**DOUBLE FILM version**) or with the upper face protected by a ply of textured polypropylene fibres preformed into film (**TEXTENE® version**) particularly suitable with upper ply that can be coloured in multi-ply adhesive packets.

PRODUCT	WEIGHT THICKNESS	FINISH UPPER	FINISH LOWER	REINFORCING MAT	SIZE ROLL (M)	ROLLS FOR PALLET (N.)	FIELDS (*) OF USE
STICKER HP TEXTENE (with box)	2 mm	Textene	Grey Siliconised Film	NT/ST	15 x 1	20	C-E-I
	3 mm	Textene	Grey Siliconised Film	NT/ST	10 x 1	20	B (●) -C-E-I
STICKER HP DOPPIO FILM (with box)	2 mm	Black HDPE Film	Grey Siliconised Film	NT/ST	15 x 1	20	C
	3 mm	Black HDPE Film	Grey Siliconised Film	NT/ST	10 x 1	20	C

(●) Duly coloured.

> STICKER HP ARD -25°C CE

Pre-fabricated self-adhesive waterproofing membrane obtained by co-extrusion layered with special elastomeric-based compounds and particular adhesive additives.

The lower face of the membrane is protected by a grey silicone film that needs to be removed at the time of application. Mineral slate flakes protect the upper face. Specific for upper finish layers in self-adhesive and under roof tile multi-ply.

PRODUCT	WEIGHT THICKNESS	FINISH UPPER	FINISH LOWER	REINFORCING MAT	SIZE ROLL (M)	ROLLS FOR PALLET (N.)	FIELDS (*) OF USE
STICKER HP ARD (with box)	3.5 kg		Grey Siliconised Film	NT/ST	8 x 1	20	B-G
	4 kg		Grey Siliconised Film	NT/ST	8 x 1	20	B-G
	3.5 kg	(*)	Grey Siliconised Film	NT/ST	8 x 1	20	B-G
	4 kg	(*)	Grey Siliconised Film	NT/ST	8 x 1	20	B-G
STICKER HP ARD ENERGY SAVING (with box)	3.5 kg	Bianco Reflecta	Grey Siliconised Film	NT/ST	8 x 1	20	B
	4 kg	Bianco Reflecta	Grey Siliconised Film	NT/ST	8 x 1	20	B

(*) Minimum order approx. 1000 m².

MEMBRANES SELF-ADHESIVE

The STICKER self-adhesive membranes are recommended for waterproofing roofs for:

- structures that are easily flammable (WOOD),
- flame-sensitive supports (INSULATING MATERIALS),
- industrial areas where the use of naked flames is prohibited.

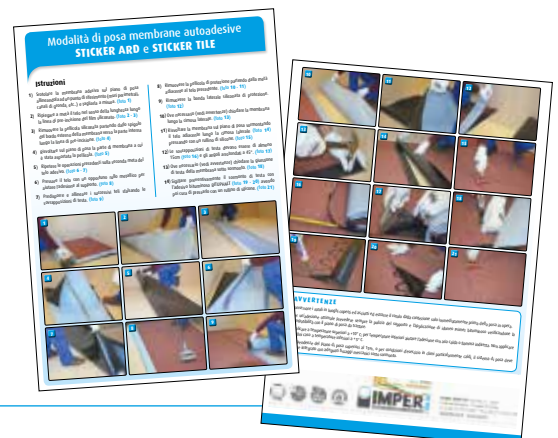

> **STICKER BIADESIVO -25°C**

Pre-fabricated double sided waterproofing membranes obtained by co-extrusion with special elastomeric-based compounds and particular adhesive additives.

The lower and upper face of the membrane are protected by a grey silicone film, it must be removed at the time of application. Specification for self-adhesive multi-ply systems and as vapour shield under insulating panels glued directly to the self-adhesive membrane.

PRODUCT	WEIGHT THICKNESS	FINISH UPPER	FINISH LOWER	REINFORCING MAT	SIZE ROLL (M)	ROLLS FOR PALLET (N.)	FIELDS (*) OF USE
STICKER BIADESIVO - DOUBLE SIDED (with box)	2 mm	Grey Siliconised Film	Grey Siliconised Film	NT/ST	15 x 1	20	H
STICKER BIADESIVO - DOUBLE SIDED VAPOR STOP (with box)	2 mm	Grey Siliconised Film	Grey Siliconised Film	AL+NT/ST	15 x 1	20	H

> **STICKER -15°C**

Pre-fabricated self-adhesive membrane obtained by co-extrusion layered with special compounds based on selected bitumen, modified with elasto-thermoplastic polymers and a reinforcing mat of "non-woven fabric" made with stabilised composite polyester.

The finish of the upper face is TERMOTENE®. Self-adhesive application upon removing the siliconised film.

PRODUCT	WEIGHT THICKNESS	FINISH UPPER	FINISH LOWER	REINFORCING MAT	SIZE ROLL (M)	ROLLS FOR PALLET (N.)	FIELDS (*) OF USE
STICKER (with box)	3 mm	Black HDPE Film	Grey Siliconised Film	NT/ST	10 x 1	20	C-E-I
STICKER (without box)	3 mm	Black HDPE Film	Grey Siliconised Film	NT/ST	10 x 1	25	C-E-I
STICKER TEXTENE (with box)	3 mm	Textene	Grey Siliconised Film	NT/ST	10 x 1	20	C-E-I
STICKER (without box)	3 mm	Textene	Grey Siliconised Film	NT/ST	10 x 1	25	C-E-I

> **STICKER ARD -15°C**

Pre-fabricated self-adhesive waterproofing membranes obtained by co-extrusion layered with special elastoplastomeric based compounds and particular adhesive additives.

The lower face of the membrane is protected by a grey silicone film that needs to be removed at the time of application. Mineral slate flakes protect the upper face. Specific for under roof tile. Self-adhesive application upon removing the siliconised film.

PRODUCT	WEIGHT THICKNESS	FINISH UPPER	FINISH LOWER	REINFORCING MAT	SIZE ROLL (M)	ROLLS FOR PALLET (N.)	FIELDS (*) OF USE
STICKER ARD (with box)	3.5 mm		Grey Siliconised Film	NT/ST	8 x 1	20	G
	3.5 mm	(*)	Grey Siliconised Film	NT/ST	8 x 1	20	G
	4 mm		Grey Siliconised Film	NT/ST	8 x 1	20	G
	4 mm	(*)	Grey Siliconised Film	NT/ST	8 x 1	20	G
STICKER ARD (without box)	3.5 mm		Grey Siliconised Film	NT/ST	10 x 1	25	G
	3.5 mm	(*)	Grey Siliconised Film	NT/ST	10 x 1	25	G
	4 mm		Grey Siliconised Film	NT/ST	10 x 1	25	G
	4 mm	(*)	Grey Siliconised Film	NT/ST	10 x 1	25	G

(*) Minimum order approx. 1000 m².

> IMPERTENE PRIMER

Highly covering bituminous primer for cement or porous substrates in general, based on selected bitumen in suitable solvents.

Used on concrete surface before installing bituminous waterproofing products in order to set the residual dustiness of the substrate and favour adhesion of the waterproofing materials.

PRODUCT	PACKAGE	SMALLEST UNIT OF SALE	PRICE PER PALLET (N.)
IMPERTENE PRIMER	5 litre can	1	1 x 125
	10 litre can	1	1 x 80
	20 litre can	1	1 x 48

> PRIMER BIT

Solvent bituminous primer for cement and in general porous substrates.

Significant fastening and impregnating effect, encouraging adhesion when applying bituminous membranes.

PRODUCT	PACKAGE	SMALLEST UNIT OF SALE	PRICE PER PALLET (N.)
PRIMER BIT	20 litre can	1	1 x 48

> PRIMER WB



Water based primer with selected bitumen for cement and porous substrates in general.

It replaces the most common solvent-based primers; it is not flammable and does not release foul odours during the application and drying phase. To be applied before laying the bituminous membranes in order to promote adhesion and fixing of residual dustiness.

PRODUCT	PACKAGE	SMALLEST UNIT OF SALE	PRICE PER PALLET (N.)
PRIMER WB	5 litre can	1	1 x 125
	10 litre can	1	1 x 80
	20 litre can	1	1 x 33



> NEROBIT

Black protective paint based on bitumen oxidised in quick drying solvent ("Tar varnish").

Water repellent and anti-corrosion protective agent for metal structures and gutters, for painting concrete tanks or objects in general and as a primer for metal or cement surfaces to be covered with bituminous products. Used in the naval industry to protect boxes, anchors and chains.

PRODUCT	PACKAGE	SMALLEST UNIT OF SALE	PALLET
NEROBIT	1 litre can	24	24 x 10
	3 litre can	8	8 x 12
	5 litre can	1	1 x 125
	10 litre can	1	1 x 80
	20 litre can	1	1 x 48

> PARWENOL

Metallic paint in synthetic-bituminous carrier for polymer distilled bitumen membranes.

PRODUCT	PACKAGE	SMALLEST UNIT OF SALE	PRICE PER PALLET (N.)
PARWENOL	5 litre can	1	1 x 48

> ELASTOMUL G



Water dispersed synthetic polymer based paint with a particularly elastic structure specific for coating bituminous membranes.

PRODUCT	PACKAGE	SMALLEST UNIT OF SALE	PRICE PER PALLET (N.)
ELASTOMUL G - White Reflecta	20 kg Bucket	1	1 x 33
ELASTOMUL G - Grey	20 kg Bucket	1	1 x 33
ELASTOMUL G - Oxide Red	20 kg Bucket	1	1 x 33
ELASTOMUL G - Green	20 kg Bucket	1	1 x 33

> ELASTOMUL SB

Solvent-based protective paint for waterproofing pavements in polymer distilled bitumen membrane.

PRODUCT	PACKAGE	SMALLEST UNIT OF SALE	PRICE PER PALLET (N.)
ELASTOMUL B - Bianco	20 kg can	1	1 x 33
ELASTOMUL B - Grey	20 kg can	1	1 x 33
ELASTOMUL B - Oxide Red	20 kg can	1	1 x 33
ELASTOMUL B - Green	20 kg can	1	1 x 33

GENERAL SALES CONDITIONS

- 1)** The goods are considered delivered ex-works at our Mappano Plant.
- 2)** The goods always travel at the risk and responsibility of the Purchaser, even if shipped free port.
- 3)** Any delivery defect must be immediately contested with the carrier through "with reserve" or on the copy of the delivery note.
- 4)** Once 8 days have passed from when the goods are received, claims will not be accepted. No return of goods, even if purchaser substantiates it with a motivation, will be accepted unless previously agree upon and authorised by us.
- 5)** The prices shown are exclusive of VAT (at the current rate).
- 6)** Quotations are subject to variations due to sudden increase in raw material prices. The company reserves the right to change the price list at any time.
- 7)** No liability is accepted for delivery delays, even within the explicitly accepted terms.

